



E-Access[®]

B-3900B Access Control Reader Instructions



Features

- 1 Administrator, 1000 users
- Built-in tamper alarm and buzzer 85dB
- User Management: Add/delete/view user data, grant user access for specific dates or time periods, change user passcode.
- Audit Trail logs for last 1000 events
- The keypad will be disabled for one minute when 3 failed passcode attempts.

Specifications

- Voltage (Input): 12 to 24 VDC
- Current Draw:
Standby current: 16mA@12VDC, 7mA@24VDC
Working current: 18mA@12VDC, 9mA@24VDC
- Bluetooth Module: BLE 4.2
- Operating distance : Up to 50 meters(164 ft) without blocking by metal or concrete wall/door frame.
- Smartphone Compatibility: Android 5.0 to 8.0, iOS 9.0 and up
- Finishes/Colors: Dark Brown or Navy

B-3900B Wiring Diagrams

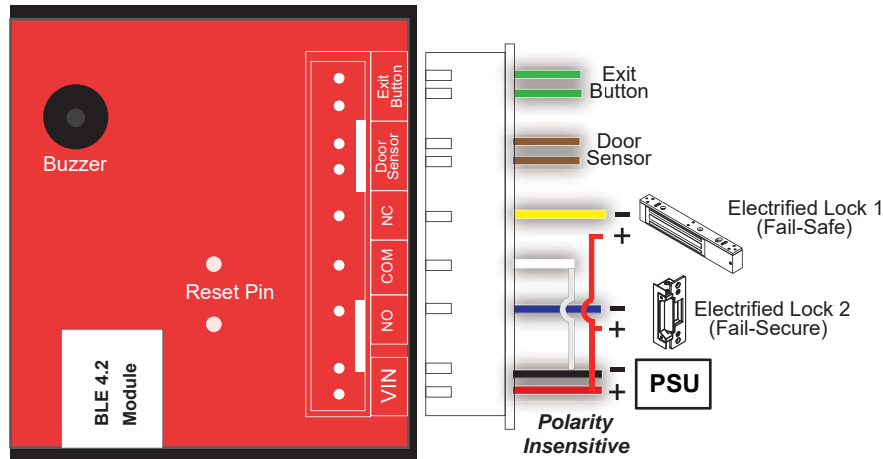

Reset Procedures

How to Reset a Bluetooth Reader with Reset Pins on the PC board?

1. Power off Access Control Reader.
2. Short the two Reset Pins, then power on.
3. Hear a long beep to complete resetting procedures.
4. Login as Admin and check all users, audit trail events are all cleared and all data is reset to factory default setting, except device name and device time.

Crimp connectors included:

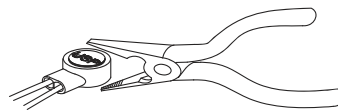

Crimp Connector



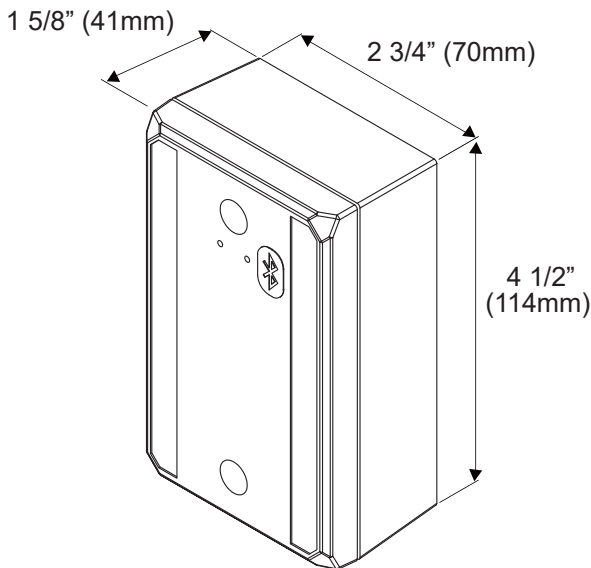

Use a pair of crimping pliers designed to crimp insulated connectors.

Place the crimp connector into the compression slot. Be sure the crimping jaws are positioned over the stripped portion of the wire. Squeeze the handles together with enough force to crush the end of the butt splice.

B-3900B Dimensions



B-3900B Screw Package

 x2	 x4
Flat head phillips screw 4 x 12mm	Cover cap
 x4	 x4
Truss head phillips screw 4 x 26mm	Anchor bolt
 x10	
Crimp Connector	

LED & Audible Indicators

LED	Reader Status
Solid Blue	Power on, Standby mode
Blue Flashing	Bluetooth is connecting
Green	Unlocked, Door always unlocked
Red	Invalid Access, Door always locked

Audible Beeps	Status
1 Short beep	Key press
1 Long beep	Valid Access, Reset is completed
2 Short beeps	Login completed
3 Short beeps	Login failure
Constant beeping	Bluetooth keypad vandalized, Door Sensor is ON

B-3900B APP

(a) Download B-3900B APP



Download the B-3900B APP to set up. Scan QR code on the left or go to Apple Store or Google Play depending on what kind of smartphone you use.

(b) B-3900B App for Administrator and Users

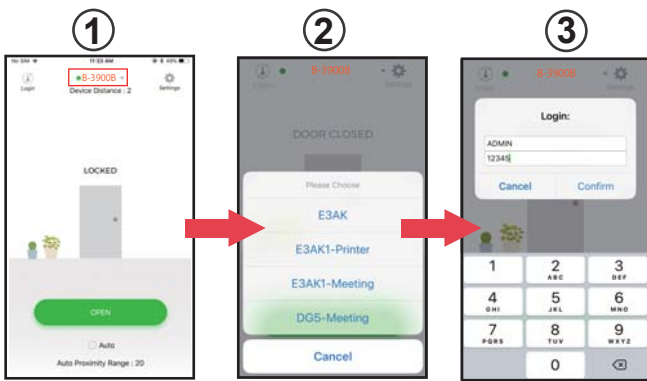

Press ① to go to Devices page. Select the designated Bluetooth device as shown on ②.

Login first,

• Administrator : Enter Admin ID and Admin Passcode to login.

Default Admin ID: ADMIN

Default Admin Passcode: 12345

• User : Enter User ID and User Passcode to login.

User ID and User Passcode are given by the Administrator.

[Note]

1. Administrator ID "ADMIN" can not be changed. we recommend changing Admin's default passcode "12345" right after you login as the Admin. Go to settings page, tap Admin Passcode to Edit Admin Passcode.
2. Admin passcode and User passcode are also used as keypad Passcode access.

(c) Administrator Settings Page

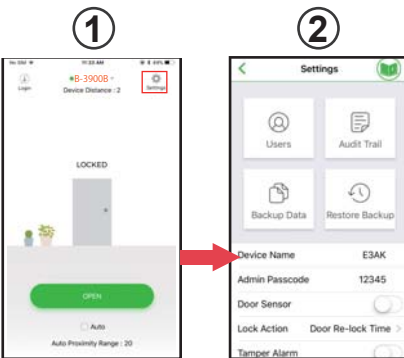





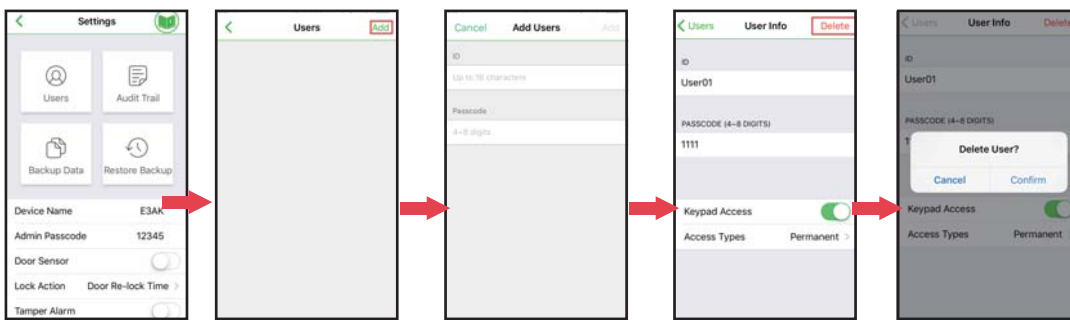



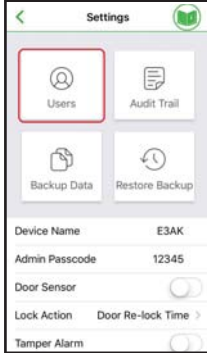
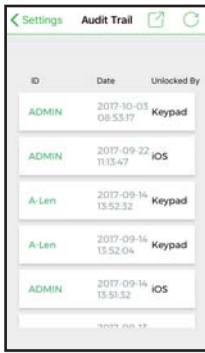

Press  ① to go to "Settings" page as shown ②.

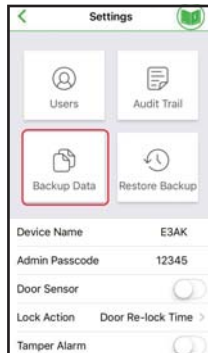
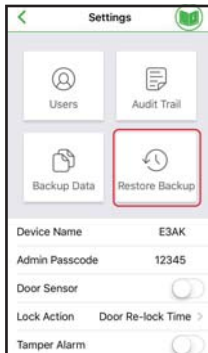
(d) Administrator Settings Page Users Management Add / Delete / Edit User Information

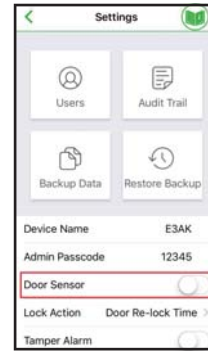

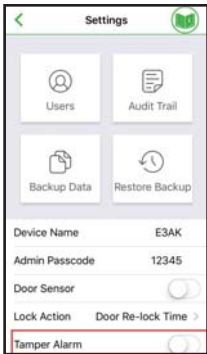

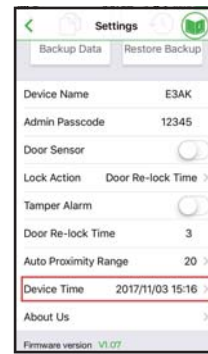
Press "Users" to edit individual user's information. You can add a user, delete a user, and select individual user to give specific settings.

Administrator Settings Page Introductions :

<h3>Users</h3>  <p>You can Add / Delete / Edit user information.</p>	<h3>Audit Trail</h3>  <p>Audit Trail is tracking last 1000 event logs, including Tamper Alarm. Audit Trail can be exported in an excel file. Tap  to export all events to excel file. Tap  to refresh all events.</p>	<h3>Backup Data</h3>  <p>Backup Data is to backup all data to Administrator's phone and can be restored except Device Name, Audit Trail logs and Device Time.</p>	<h3>Restore Backup</h3>  <p>You can restore the last backup data to a new Access Control Keypad / Reader.</p>
<h3>Device Name</h3>  <p>Device name can be edited as a model number, Office, Front door, Gate, etc.</p>	<h3>Admin Passcode</h3>  <p>12345 is Admin default passcode. It's important to change your Admin passcode immediately.</p>	<h3>Door Sensor</h3>  <p>You can enable Door Sensor when you connect to a closed-circuit magnetic sensors or a monitored door lock that has door sensor (or lock sensor) outputs to monitor the open or closed state of a door.</p>	<h3>Lock Action</h3>  <p>3 options. You can choose Door Re-lock Time, Door Always Unlocked and Door Always Locked.</p>
<h3>Tamper Alarm</h3>  <p>Tamper Alarm is deactivated by default. You can activate Tamper Alarm. If the device is vandalized, the tamper alarm will howl immediately and won't go off until it's switched off by Administrator.</p>	<h3>Door Re-lock Time</h3>  <p>You can set the door re-lock time interval between 1 to 1800 seconds.</p>	<h3>Device Time</h3>  <p>Make sure to set up Device Time precisely as your current time zone of where you are. It helps having correct and precise access data and information.</p>	<h3>About Us</h3>  <p>Tap "About Us" to show Device Model, APP version, website and E-Mail information.</p>

B-3900B APP

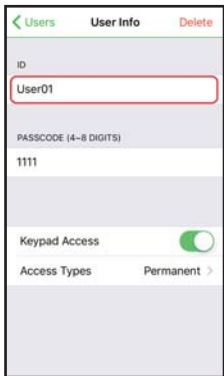
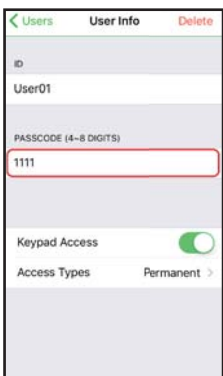
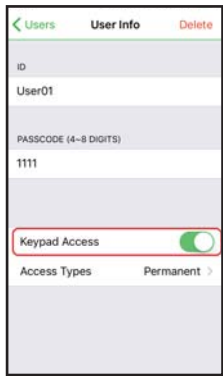
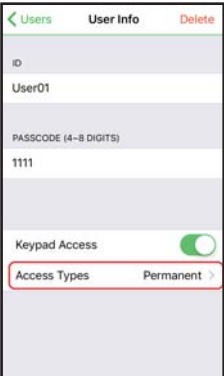
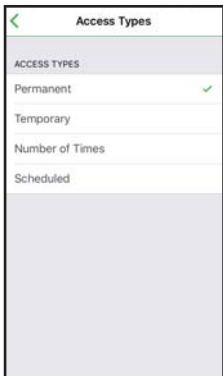
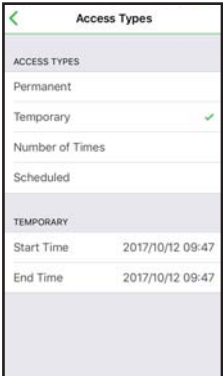
Administrator Settings Pages – Users Management Edit User Information

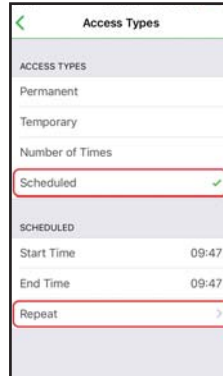
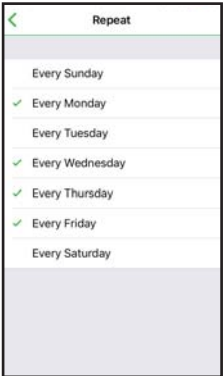
<p style="text-align: center;">ID</p>  <p>Tap user " ID" to Edit ID.</p>	<p style="text-align: center;">PASSCODE</p>  <p>Tap user "PASSCODE" to Edit PASSCODE.</p>	<p style="text-align: center;">Keypad Access</p>  <p>You can enable/disable keypad access for a user.</p>
<p style="text-align: center;">Access Types</p>   <p>Tap "Access Types" to choose Permanent, Temporary, Number of Times, or Scheduled. The App is set to give Permanent access by default.</p>		<p style="text-align: center;">Temporary</p>  <p>Tap " Temporary" to set specific access time periods.</p>
<p style="text-align: center;">Number of Times</p>  <p>Tap "Number of Times" to set number of access granted to user.</p>	<p style="text-align: center;">Scheduled</p>   <p>Tap "Scheduled" to assign repeatedly access on specific days and hours for a certain period of time. This setting is useful for house cleaners and other guests that need temporary access on regular basis.</p>	

B-3900B APP

Auto Proximity Range Adjustment and Auto unlock Function Administrator Interface:

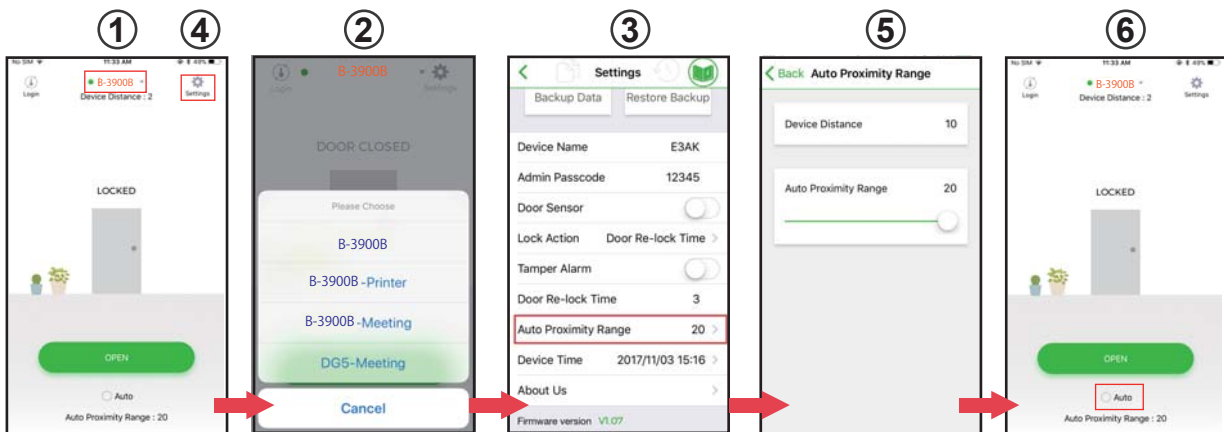

figure ① Tap ① to go to Device list page as ②.

figure ② Select the desired Bluetooth Access Control Keypads/Readers around you.

Tap ④ Settings button to go into Settings page as figure ③ to select "Proximity Read Range"

figure ⑤ Adjust "Auto Proximity Range" for Auto unlock function between 0 to 20.

figure ⑥ Back to the main page. Tap "Auto" to enable Auto unlock function to access.

Auto Proximity Range Adjustment and Auto unlock Function User Interface:

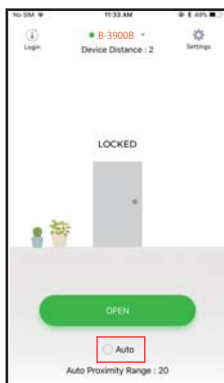
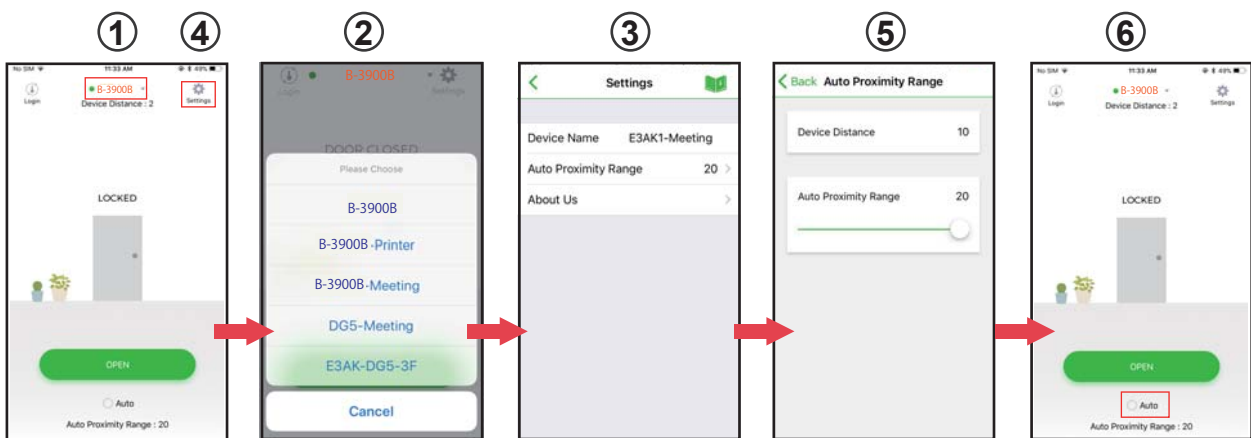

figure ① Tap ① to go to Device list page as ②.

figure ② Select the desired Bluetooth Access Control Keypads/Readers around you.

Tap ④ Settings button to go into Settings page as figure ③ to select "Proximity Read Range"

figure ⑤ Adjust "Auto Proximity Range" for Auto unlock function between 0 to 20.

figure ⑥ Back to the main page. Tap "Auto" to enable Auto unlock function to access.

Note:

Make sure to disable Auto before pressing  to enter Settings page.

B-3900B Operation Instructions

Note:

Stand next to the B-3900B Bluetooth reader when you want to connect the Smartphone to unlock or login, the Bluetooth reader can detect signal up to 50 meters (164 ft) distance. The response time of Bluetooth signal may vary depend on various mobile device models.

