



Single Door Access Control Kit Operation Manual

ROFU 9112 BT-KIT

ROFU Security International Corp.
10029 S. Tacoma Way, E-11
Lakewood, WA 98499 USA
1-800-255-7638 (1-800-ALL-ROFU)
www.ROFU.com
OrderEntry@rofu.com

9910 Specifications

- 1 Master, 196 Users
- Bluetooth Low Energy 4.0 Standard
- Operating distance: 50 meters
- Proximity distance: 50 meters (Configurable, for hands-free operation)
- Operating Temperature: +14° to +104°F (-10° to +40°C)
- Relay current: 5A max
- Mobile Compatibility: iOS 9.0 and up, Android 4.4 and up

9910 Operation Features

- Bi-Stable Relay:
 - o To enable Bi-stable function, press down the E button on the smartphone screen for few seconds. The door will then remain unlocked indefinitely.
- LED Lights:
 - o Blue (Bluetooth is active)
 - o Green (Unlock status)
 - o Red (Power reset)
- Buzzer: 85 dBA, Ideal to warn of prolonged door open.
- Resetting/Changing Master Account:
 - o Restart the power of 9910 Bluetooth device. Enter the password 12345(default) within 30 seconds to log onto the E-Access system. Complete the registration and the Master account is reset/changed.

Note: To skip the 30 sec wait, press an exit button that you may have already installed, and the LED light on the reader will then change from Red to Blue.

Unlocking Door from Smartphone

- Manual Operation: After registration is completed, press the E button on the main page to unlock the door.
- Automatic Access Operation: After registration is completed, set proximity read range, and then turn on automatic access function on the main page for hands-free access.

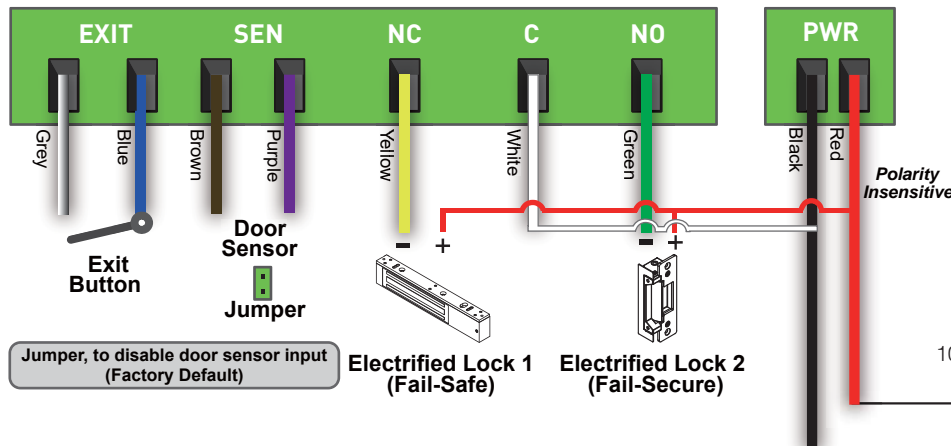

Wiring Diagram

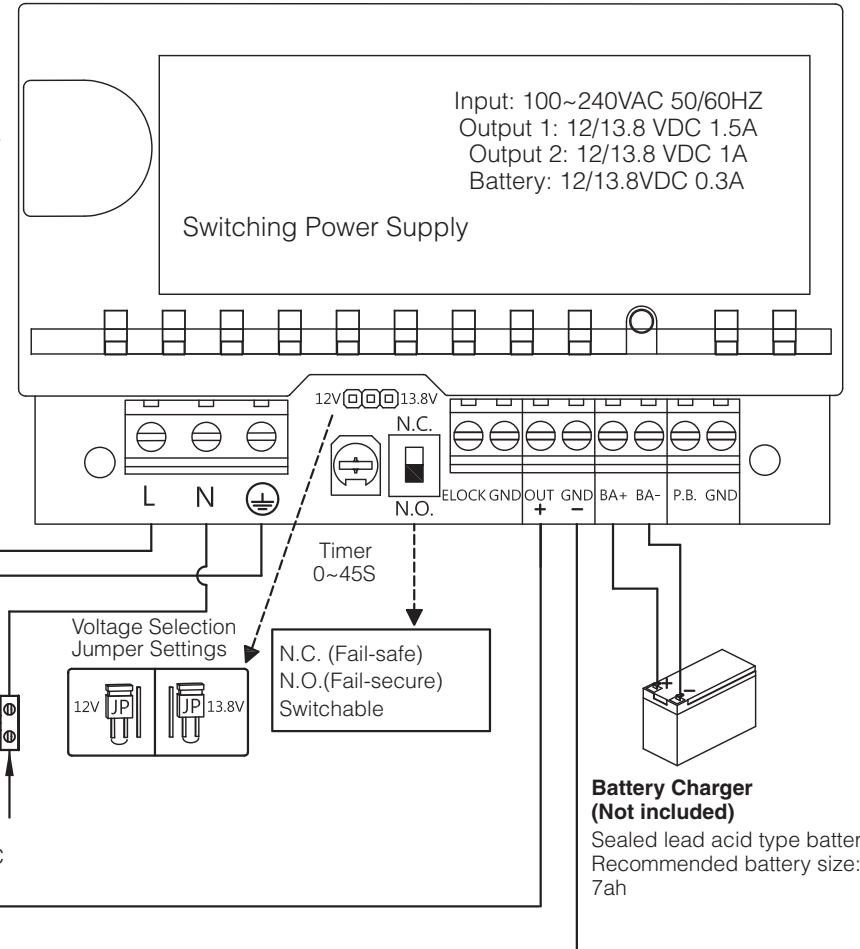

Crimp connectors included:

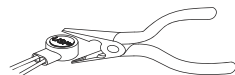

Crimp Connector →

Use a pair of crimping pliers designed to crimp insulated connectors.

Place the crimp connector into the compression slot. Be sure the crimping jaws are positioned over the stripped portion of the wire. Squeeze the handles together with enough force to crush the end of the butt splice.

Enclosure Specifications

- Dimensions: 8 1/4" x 8 11/16" x 3 1/8" (210 x 220 x 80 mm)
- LED status indicators: AC light (Red): AC voltage input
DC light (Green): DC / battery voltage output
Battery light (Yellow): Battery voltage below 10 VDC

Note: Relock time is set by 9910 bluetooth access control reader.

E-Access® 9910 Operation Instructions Operation Procedure

Note: The Bluetooth signal has a range of 0-50 meters. When registering on the app, the master/users must stand in front of the 9910 Bluetooth device with which they want to connect with their phones. Once registration is completed, the master/users can unlock the door with their phones.

Step 1

Master downloads the 9910 app through Google Play or Apple Store and completes registration on the app.

Step 2

Master adds a new user account name and password on the app.

Step 3

Master informs the user of account name and password. The user downloads the app and completes registration.

Step 4

The user can open the door with smartphone or change the password.

Access Control Management

After registration is completed, the master can proceed to performing other settings for access control. See the following steps 6-10 for further instructions.

4

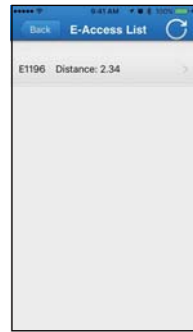

Master / User Logon E-Access:

Select an E-Access device from the E-Access List and enter the password given by the Master.

Logon Notes:

1. The Master / User must enter a correct Password to logon.
2. How to Reset/Change the Master account:
 - (1) Restart the power of E-Access device, and then enter the password 12345 (default) within 30 seconds.
 - (2) Next, click on the "Register" button to register, then return to the first page, and you then become the Master.

8

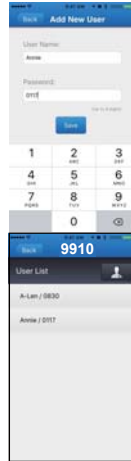

Add New User:

Add User Name:

The Master enters a User name.

Password:

The Master assigns a password for the new User to register on E-Access system.

The new user will be shown on the User list.

9910 App Instructions

1

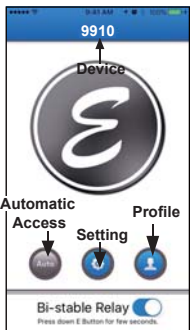

Introduction of App's Main Page

Profile:
Enter a Master / User name for this phone only at the first time.

Setting:
E-Access Device Settings Page.

Device:
E-Access Device Name.

Auto:
(Automatic Access for Handsfree): Turn ON/OFF for the Automatic Access Handsfree function.

Bi-stable Relay:
When you select to enable Bi-stable function, you can press down the E button for few seconds to activate and keeps the door unlocked indefinitely. To return to normal function, press the E button again.

5

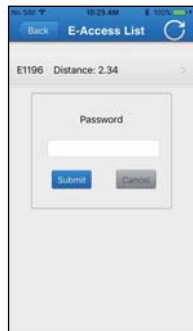

Master / User Logon E-Access:

Select an E-Access device from the E-Access List and enter the password given by the Master.

Logon Notes:

1. The Master / User must enter a correct Password to logon.
2. How to Reset/Change the Master account:
 - (1) Restart the power of E-Access device, and then enter the password 12345 (default) within 30 seconds.
 - (2) Next, click on the "Register" button to register, then return to the first page, and you then become the Master.

9

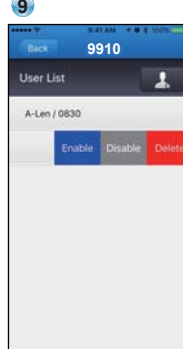

Master can slide from right to left so a User can be Enabled /Disabled/Deleted by the Master.

Enable:

Enable a User account.

Disable:

Disable a User account.

Delete:

Delete a User account.

2



Click on the device name (e.g.9910 as shown) and pull down all the available E-Access devices around you.

You can select a device from the list as shown, or you can press "Auto" in the list so that E-Access will operate with the closest E-Access device around you.

6



Master Setting Page:

Register:
You must click on Register button to complete registration before opening the door by your phone.

User List:
Only the Master can view/enable/delete all the Users and view User passwords.

Settings:
E-Access settings include Proximity Read Range, Device Name, Relock Time, and Delete all Users.

Backup:
Backup all Users data from the device.

Restore:
Restore the last backup data.

Change Password:
We recommend changing Master's password right after you reset/change the Master account. (Default Master password:12345)

10

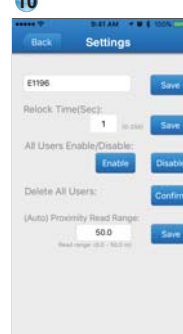

Settings Page

E-Access Name:
Edit the E-Access name.

Relock Time (sec):
Set the time for relock time.

Enable/Disable All Users:
Enable or disable all User accounts except the Master.

Delete All Users:
Delete all User accounts except the Master.

Proximity Read Range (from 0 to 50 meters):
Set proximity read range for hands-free automatic access.

3



Enter personal name.

7



User List:

All authorized Users can be viewed on the User List. Click on to add a new User.

Scan the QR-code to download E-Access 9910 App or Search "E-Access 9910" to download.



Scan the QR-code to download 9910 Instructions.



<http://www.rofu.com/pdf/installation/9212KIT.pdf>