

# ROFU 10320HD Heavy Duty Door Cord Installation Instructions

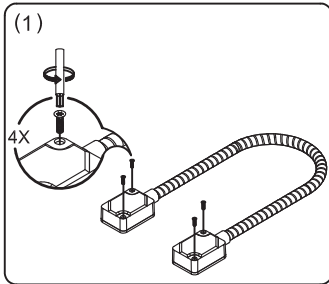

## Installation Steps



Turn the head cover screws counterclockwise to loosen them.

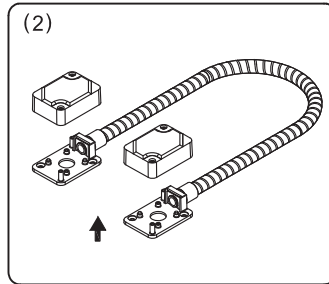

Remove the head covers.

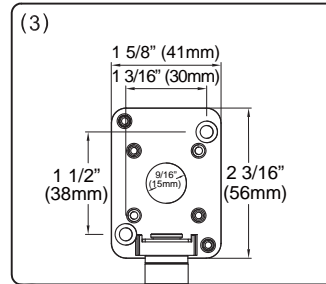

Align the two ends with the intended positions, and mark on the door and frame.

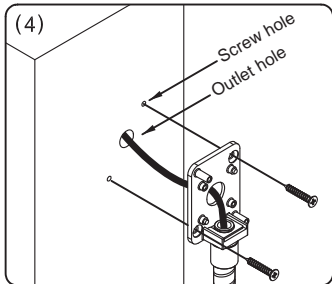

Drill holes in the marked positions, and secure the two ends by using 4x25 screws.

Screw hole diameter: 1/8" (3.3mm)

Outlet hole diameter: 1/2" (12mm)

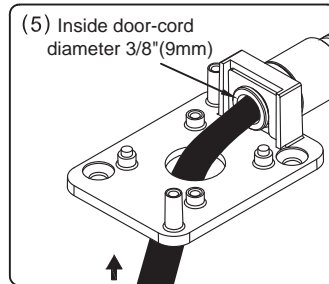

Connect the wire to each end of the cord and test the unit.

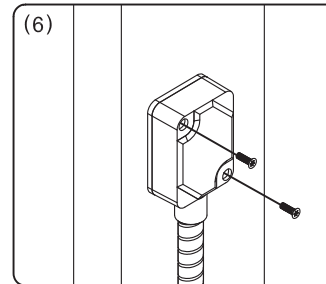

Mount the head covers and tighten the screws.

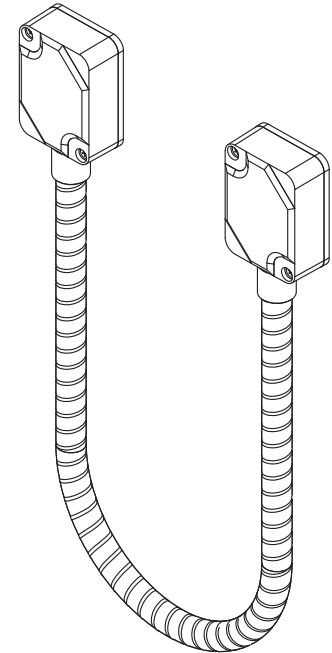

# ROFU 10320HD-PCB Heavy Duty Door Cord Installation Instructions



## Installation Steps

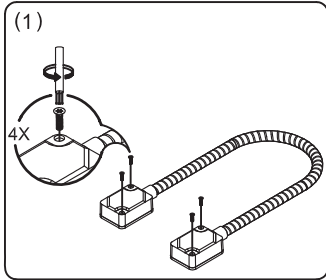

(1) Remove the security screws using the enclosed tool.

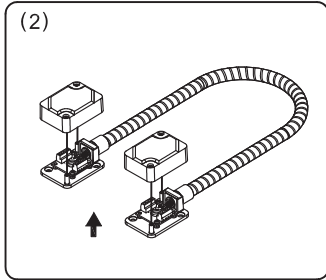

(2) Remove the head covers.

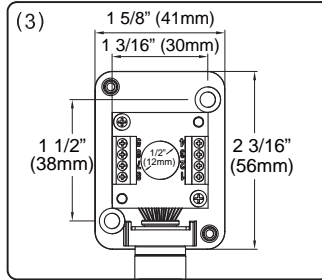

(3) Position the two end caps where you plan to mount them and mark the holes on the door and frame.

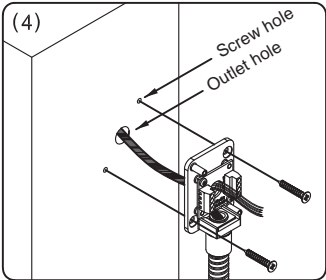

(4) Drill holes in the marked positions, and secure the two ends by using 4x25 screws.  
Screw hole diameter: 1/8" (3.3mm)  
Outlet hole diameter: 1/2" (12mm)

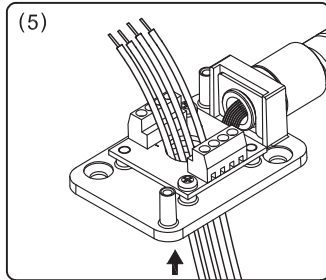

(5) Attach the wires to the PCB Board in each end and test the unit (up to 8 wires).

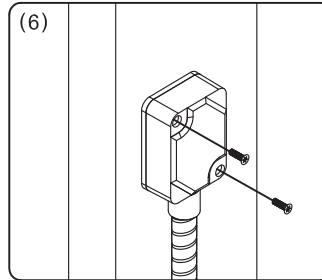

(6) Mount the head covers and tighten the screws.

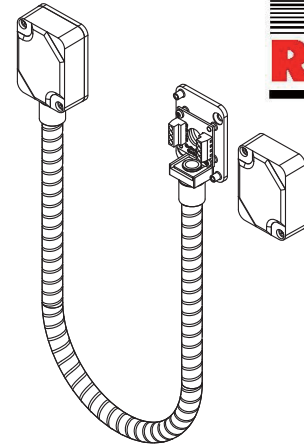

## Wiring Diagram

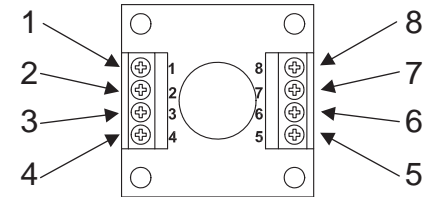

\*Each terminal is wired on a one to one basis. Whatever is wired to a particular terminal number on one block will be connected to the same terminal number on the other block.